

ARUBA

FUNKCJA

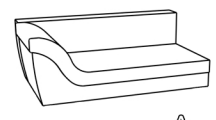

A- 1 St.

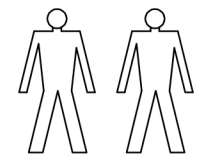
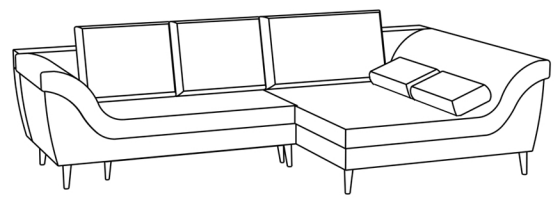
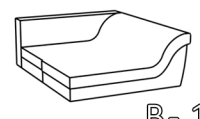

B- 1 St.



H16
C- 7 St.



H11
D- 4 St.



M10
E- 11 St.

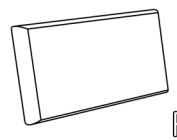

F- 1 St.

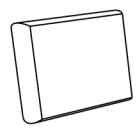

G- 2 St.

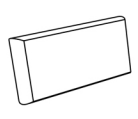

H- 2 St.

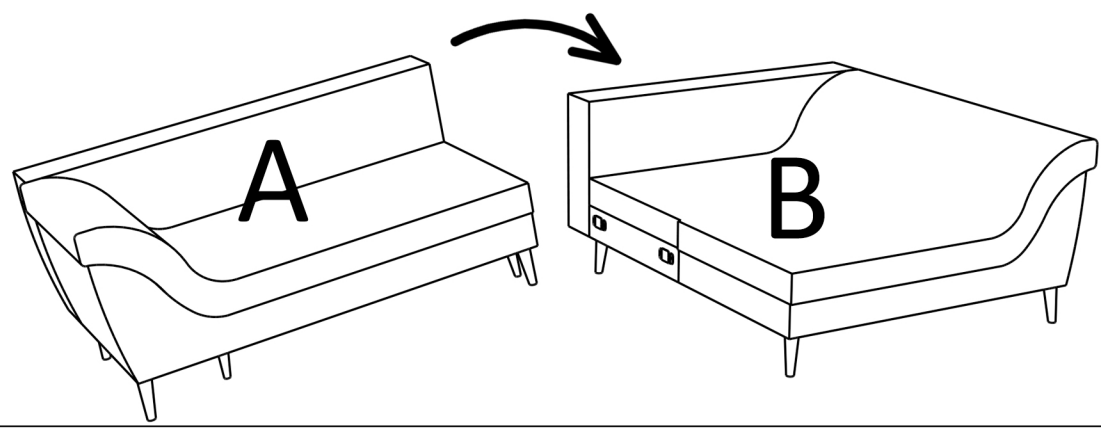
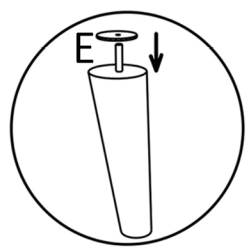
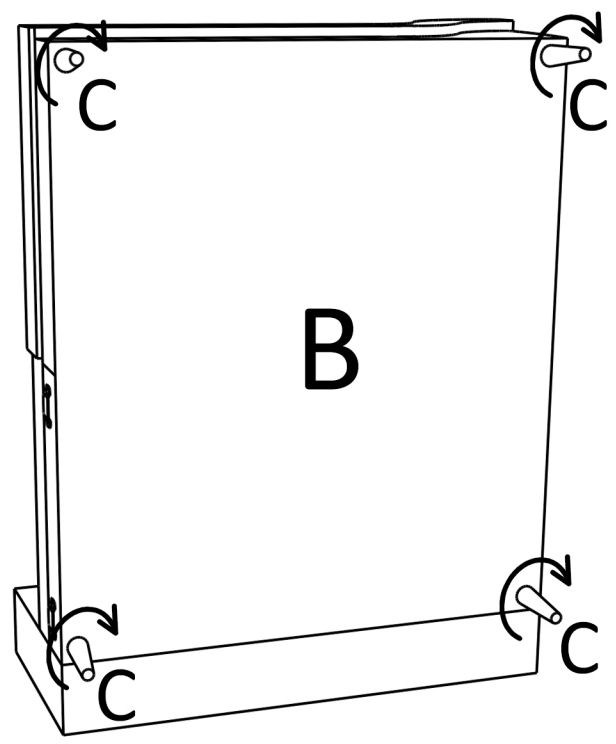
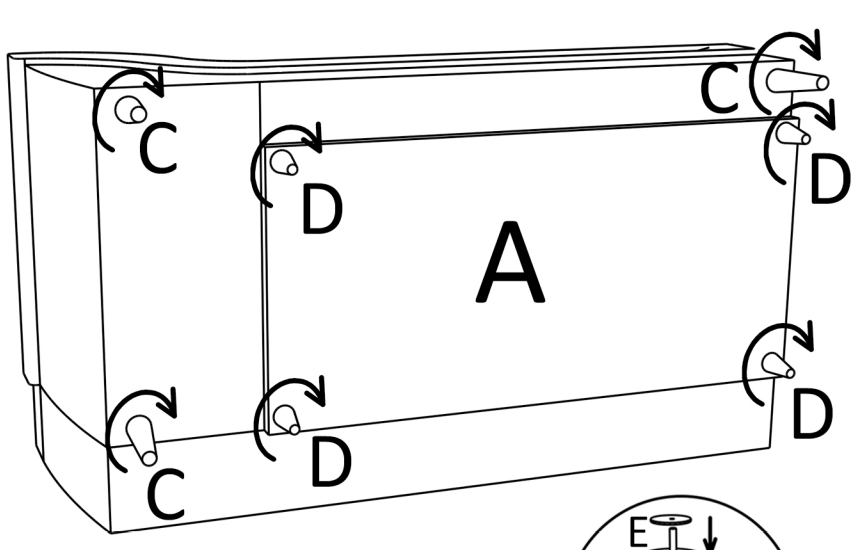
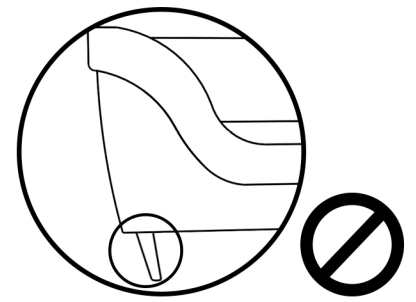
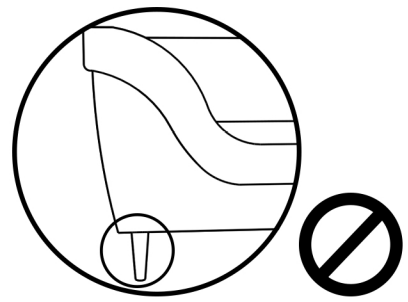
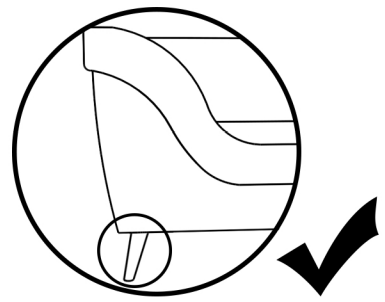

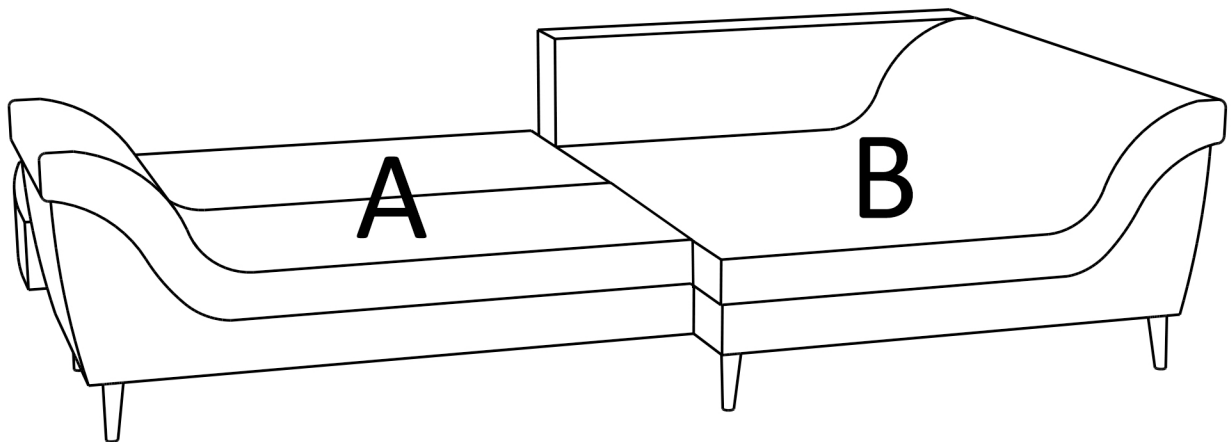
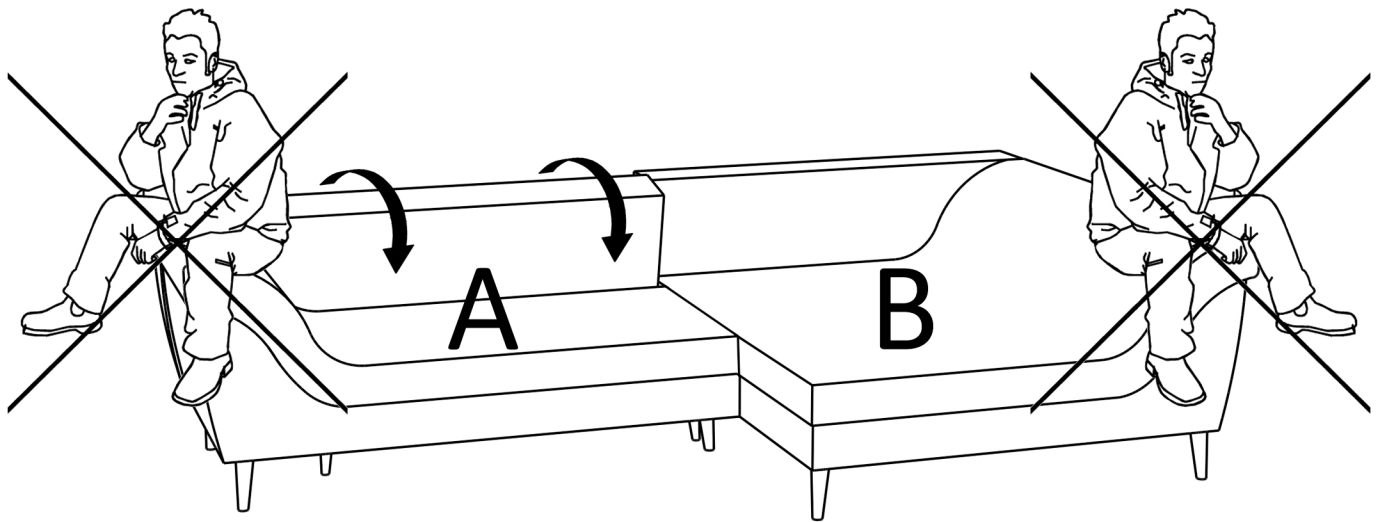
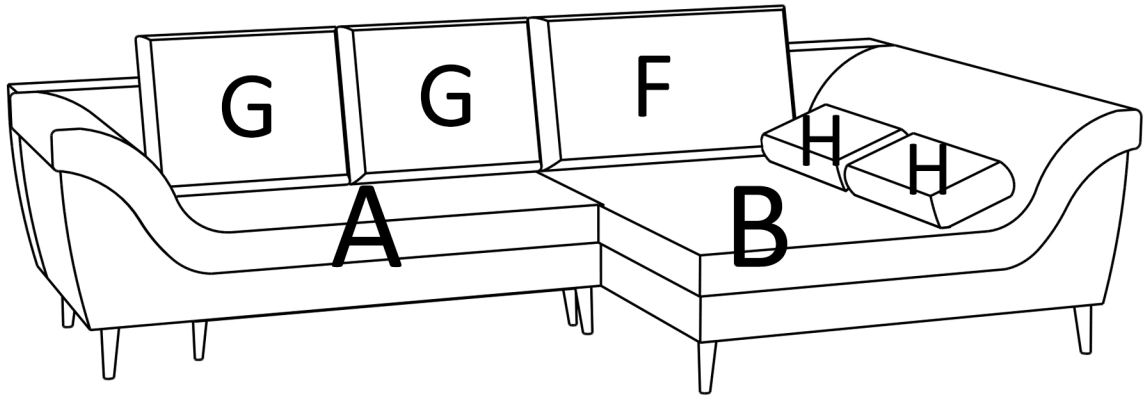

ARUBA

FUNKCJA

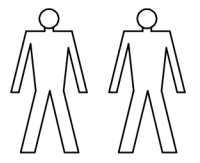
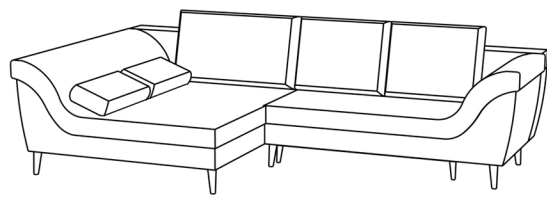

| | | | | |
|--------------|--------------|---------------------|---------------------|----------------------|
| A- 1 St. | B- 1 St. | H16 C- 7 St. | H11 D- 4 St. | M10 E- 11 St. |
| F- 1 St. | G- 2 St. | H- 2 St. | | |

