

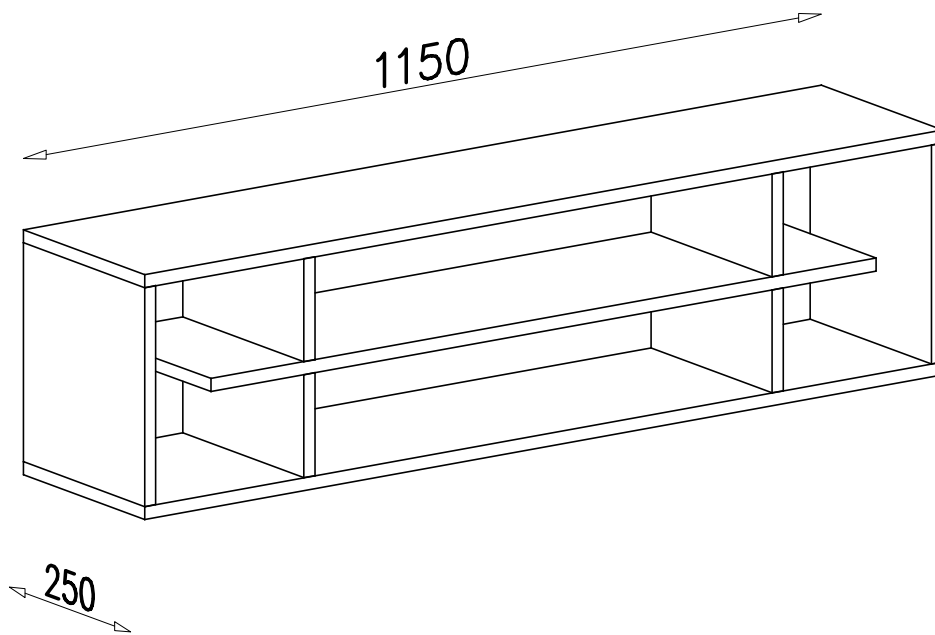

MOBI MO 15

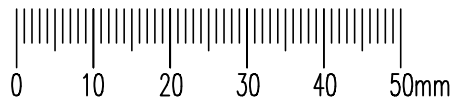
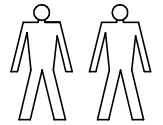
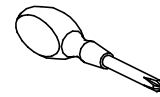
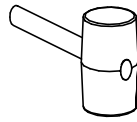
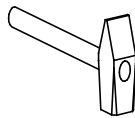
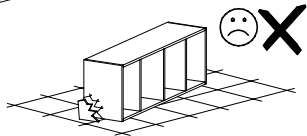
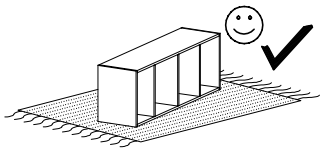

E

 3 x 20 x35

W

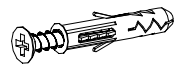
 x2

G

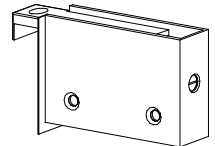
 x4

M

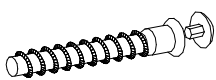
 4 x 30 x4

H

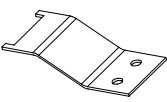
 x2

A

 x4

B

 x24

K

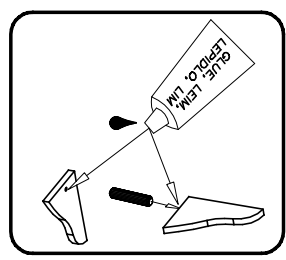
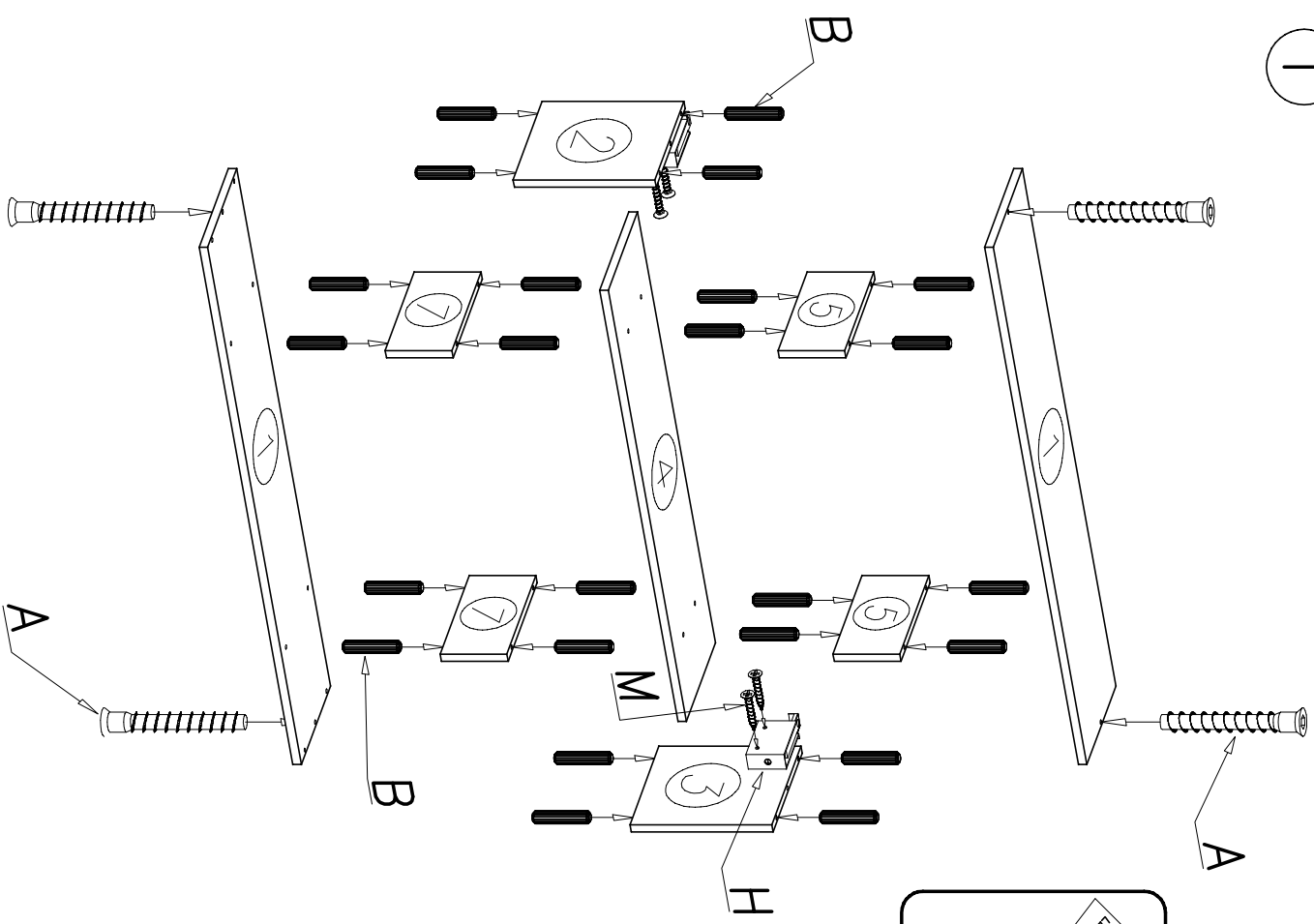
 x2

Z

 x1

1

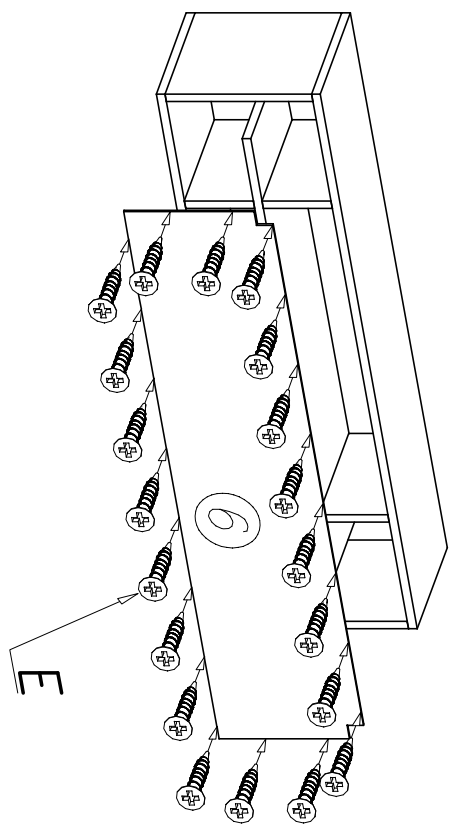

II



III

